

EN | VALID FROM 01.03.2025 - 31.12.2025

GEDORE  red

# IMPULSE<sup>25</sup>

SELECTION

TOOL TROLLEY  
MEISTER XXL



MINI WORK LAMP UV



COMBINATION RATCHET  
SPANNER SET



# 85 TOOLS, 17 HIGHLIGHTS AND INNOVATIONS



**23** R2190 2072  
PLUMBERS  
TOOL TROLLEY

R2165 2089  
TOOL CASE  
ELECTRICIAN

**24**



**GEDORE** red















**R9560 0320**  
**INSPECTION**  
**LAMP**

**39**



## CONTENTS

	<b>RATCHET SPANNERS</b>	<b>04 – 07</b>
	<b>SOCKET SETS</b>	<b>08 – 24, 34, 36, 43</b>
	<b>BIKE-SETS</b>	<b>19</b>
	<b>RANGE OF SOCKETS</b>	<b>25</b>
	<b>TORQUE WRENCHES</b>	<b>26</b>
	<b>SCREWDRIVERS AND BITS</b>	<b>25, 27</b>
	<b>WORKSHOP EQUIPMENT</b>	<b>28 – 33</b>
	<b>STRIKING TOOLS</b>	<b>35</b>
	<b>PLIERS</b>	<b>42</b>
	<b>1000V</b>	<b>36</b>
	<b>WORK LAMPS</b>	<b>37 – 41</b>
	<b>CUTTING / FILING / DRILLING</b>	<b>42 – 43</b>

## R0512 6008

### DOUBLE OPEN ENDED SPANNER SET

in wallet, 8 pieces

- > Acc. to DIN 895, ISO 3318, ISO 1085
- > Jaw set at 15°
- > In practical roll wallet



Code	No.	Length mm	Width mm	Height mm	Pieces	Weight kg
3301081	R05126008	235	60	60	8	0,64

#### Contents

Double open ended spanner 6x7 8x9 10x11 12x13 14x15 16x17 18x19 20x22 mm

## R0510 5012

### DOUBLE OPEN ENDED SPANNER SET

long, metric, 12 pieces

- > Acc. to DIN 3110, ISO 3318, ISO 1085, ISO 10102
- > Jaw set at 15°
- > In holder



Code	No.	Contents	Pieces	Weight kg
3300960	R05105012	Double open-end wrench 6x7 8x9 10x11 12x13 14x15 16x17 18x19 20x22 21x23 24x27 25x28 30x32 mm	12	2,42

## R0720 30XX

### COMBINATION RATCHET SPANNER SETS

- > In accordance with DIN 3113, ISO 3318
- > Ring offset to 15°, reversible for right and left hand operation
- > 72 teeth Ratchet mechanism
- > Return angle 5°
- > Jaw set at 15°
- > In rugged plastic case



Code	No.	Contents	Length mm	Width mm	Height mm	Pieces	Weight kg
3300059	R07203012	Combination ratchet spanners 8 10 12 13 15 17 18 19 mm Square end drive adaptor 1/4" for 10 mm 3/8" for 13 mm, 1/2" for 19 mm Bit adaptor 1/4" for 10 mm	275	200	53	12	15,68
3300060	R07203016	Combination ratchet spanners 8 9 10 11 12 13 14 15 16 17 18 19 mm Square drive adapter 1/4" for 10 mm 3/8" for 13 mm, 1/2" for 19 mm Bit adapter 1/4" for 10 mm	303	225	69	16	2,1

## R0590 5010

### OPEN ENDED RATCHET SPANNER SET

metric, 10 pieces

- > In accordance with DIN 3318
- > Straight pattern
- > Open end with ratchet function
- > Jaw set at 15°
- > Ring side open, offset to 15°
- > In holder



Code	No.	Contents
3301003	R05905010	Open ended ratchet spanner 10 11 12 13 14 15 16 17 18 19 mm

Pieces	Weight kg
10	1,758

## R0740 5006

### DOUBLE ENDED RING RATCHET SPANNER SET

straight, metric, 6 pieces

- > In accordance with DIN 837
- > Straight pattern
- > 72 teeth Ratchet mechanism
- > In holder



Code	No.	Contents	Pieces	Weight kg
3300898	R07405006	Double ring ratchet spanner 8x9 10x11 12x13 14x15 16x18 17x19 mm	6	0,865

## R0730 5005

### FLEXIBLE HEAD COMBINATION RATCHET SPANNER SET

5 pieces

- > In accordance with DIN 3113, ISO 3318
- > With 180° swivel head
- > 72 teeth Ratchet mechanism
- > Return angle 5°
- > Jaw set at 15°
- > In holder



Code	No.	Contents	Pieces	Weight kg
3300890	R07305005	Flexible head combination ratchet spanner 8 10 13 17 19 mm	5	1,158

**NEW**

**R0720 XXXX**

**COMBINATION RATCHET SPANNER**

reversible with hold function

- > Hold function in the ratchet head for holding and safely guiding nuts or screws and bolts
- > According to ISO 21982
- > 15° angled ring ratchet head, reversible clockwise/ anticlockwise rotation
- > Ratchet mechanism with 72 teeth
- > Jaw set at 15°
- > Matt chrome-plated surface
- > Chromium vanadium steel



Code	No.	Width across flats mm	Length mm	Weight kg
3301008	R07201080	8	138	0,03
3301009	R07201090	9	150	0,04
3301004	R07201100	10	161	0,063
3301010	R07201110	11	165	0,07
3301011	R07201120	12	165	0,08
3301005	R07201130	13	183	0,103
3301012	R07201140	14	190	0,12
3301013	R07201150	15	199	0,13
3301082	R07201160	16	209	0,14
3301006	R07201170	17	225	0,19
3301083	R07201180	18	235	0,21
3301007	R07201190	19	245	0,243

**R0910 XXXX**

**COMBINATION SPANNER SET**

metric

- > Acc. to DIN 3113, Form A, ISO 3318, ISO 7738
- > Jaw set at 15°
- > In holder



Code	No.	Pieces	Weight kg
3300988	R09105008	8	0,6

**Contents**  
Combination spanner  
8 9 10 11 13 14 17 19 mm

Code	No.	Pieces	Weight kg
3300991	R09105021	21	4,712

**Contents**  
Combination spanner  
6 7 8 9 10 11 12 13 14 15 16 17 18 19 20 21 22 24 27 30 32 mm

R0720 51XX

# COMBINATION RATCHET SPANNER SET

reversible with hold function

- > Hold function in the ratchet head for holding and safely guiding nuts or screws and bolts
- > According to ISO 21982
- > 15° angled ring ratchet head, reversible clockwise/anticlockwise rotation
- > Ratchet mechanism with 72 teeth
- > Jaw set at 15°
- > Matt chrome-plated surface
- > Chromium vanadium steel

Innovative hold function in the ring ratchet head

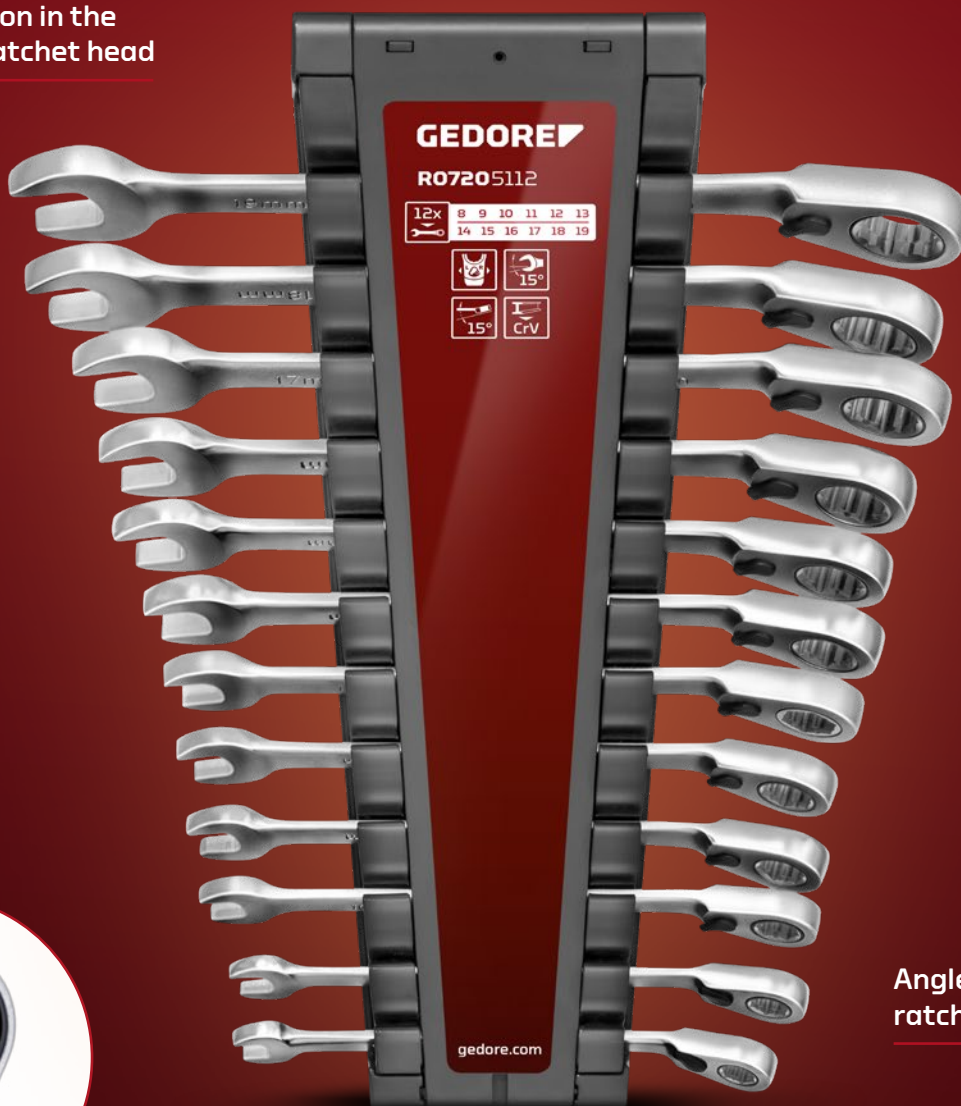

Angled ring ratchet head



Code	No.	Contents	Pieces	Weight kg
3301084	R07205106	8 10 12 13 17 19 mm	6	0,85
3301085	R07205112	8 9 10 11 12 13 14 15 16 17 18 19 mm	12	1,8

R3300 3043

# TORSION BIT SET

43 pieces

- > 43-piece torsion bit set for a multitude of screw joints
- > Flexible bit screwdriver with ratchet function (for working in confined spaces)
- > Bits with torsion zone for high stresses
- > Easy to see size marking on bits for quick access
- > For manual and machine operation



Highly stressable torsion bits

Saves time: Size marking on the bits

Bendable bit screwdriver including ratchet



Code	No.	Length mm	Width mm	Height mm	Pieces	Weight kg
3304902	R33003043	250	140	52	43	0,985

### Contents

- Ratchet screwdriver magnetic
- 1/4" Quick change adapter
- Bit adapter 1/4" hex x 1/4" square, L. 50mm
- Bit adapter 1/4" hex x 3/8" square, L. 50mm
- Socket, magnetic, with 1/4" hex drive 8 10 13 | 65mm
- 1/4" Torsion bits, 25mm:
  - PH1 (1x), PH2 (2x), 3 (1x) PZ1 (1x), PH2 (2x), 3 (1x), TX T10, T15, T20, T25, T30, T40
- Slotted 5.5, 6.5 mm
- 1/4" Torsion bits, 50mm:
  - PH1 (1x), PH2 (2x), PH3 (1x)
- Hexagon socket 3, 4, 5 mm
- PZ1 (1x), PZ2 (2x), PZ3 (1x), TX T10, T15, T20, T25, T30
- 1/4" Torsion bits, 90mm:
  - PH2 (1x), PZ2 (1x)
- Slotted 5.5 mm
- TX T25



## R3300 3051

### 1/4" BIT SET

51 pieces

- > Set with common bit sizes and drive adapter with bit lock
- > Long bits
- > Reversible ratchet with 2C-handle and 5° return angle and reversible lever for convenient change of direction
- > Bit adapter enables alternative drive of the bits with the reversible ratchet



Code	No.	Length mm	Width mm	Height mm	Pieces	Weight kg
<b>3301350</b>	R33003051	230	130	52	51	0,98

#### Contents

1/4" Sockets 4 5 5.5 6 7 8 9 10 11 12 13 14 mm  
1/4" Reversible ratchet  
1/4" Extension 100mm  
1/4" Adapter square x hexagon  
1/4" Bits 25mm:  
PH1 (1x), PH2 (2x), PH3 (1x), PZ1 (1x), PZ2 (2x), PZ3 (1x)  
Slotted 4.4 5 6.5mm  
TX T10 T15 T20 T25 T27 T30 T40  
Hexagon socket 2 3 4 5 6 mm  
Bit adapter 1/4" square x 1/4" hex  
1/4" Bits 90mm:  
PH1 (1x), PH2 (1x), PZ1 (1x), PZ2 (1x), TX T20 T25 T30  
Hexagon socket 3 4 5 6 mm  
Slotted 5.5mm

## R3300 3067

### 1/4" BIT SET

67 pieces

- > Set with common bit sizes and drive adapter with bit lock
- > Long bits
- > Screwdriver with strong magnet for quick and easy bit replacement and ergonomic grip
- > Quick-change adapter enables quick bit changes



Code	No.	Length mm	Width mm	Height mm	Pieces	Weight kg
<b>3301352</b>	R33003067	300	180	52	67	1,1

#### Contents

Offset screwdriver set 1.5, 2, 2.5, 3, 4, 5, 6 mm  
1/4" Magnetic bit screwdriver  
1/4" Quick change adapter  
1/4" Bits, 25mm:  
PH1 (3x), PH2 (2x), PH3 (1x)  
PZ1 (3x), PZ2 (2x), PZ3 (1x)  
Slotted 4, 4.5, 5.5, 6.5mm  
TX T6, T7, T8, T9, T10, T10, T15, T15, T20, T20, T25, T25, T27, T30, T30, T40, T40  
TX T10H, T15H, T20H, T25H, T27H, T30H, T40H  
Hexagon socket 2, 3, 4, 5, 6 mm  
Bit adapter 1/4" square x 1/4" hex  
1/4" bits, 90mm:  
PH1 (1x), PH2 (1x), PZ1 (1x), PZ2 (1x)  
TX T20, T25, T30  
Hexagon socket 3, 4, 5, 6 mm  
Slotted 5.5mm

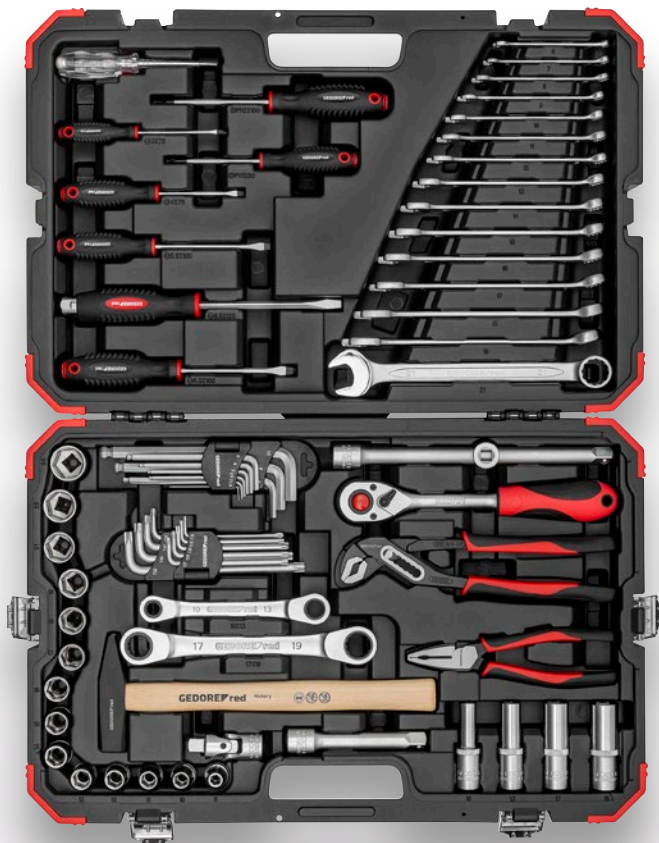

**R6900 3069**  
**1/2" SERVICE SOCKET SET**  
 69 pieces

> Ideal combination for jobs with service work

Code	No.	Length mm	Width mm	Height mm	Pieces	Weight kg
<b>3300191</b>	R69003069	552	360	100	69	9,9

**Contents**

2C reversible ratchet, right-hand/left-hand rotation can be switched by lever, push-button release, fine-toothed, oval head, 2-component handle, hand-friendly power transmission, for socket spanner inserts

Socket, hexagonal, metric, short version to DIN 3124

ISO 2725, SW 10 11 12 13 14 15 16 17 18 19 21 22 24 | 38 mm

Socket spanner insert, hexagonal, metric, long version to DIN 3124

ISO 2725, SW 10 13 17 19 | 77 mm

Socket spanner extensions 1/2" L 125 250 mm

Cardan joint 1/2", screwed joint, version to DIN 3123 - C 12.5

Enlargement adapter/sliding piece 3/8" x 1/2", for driving socket spanner and screwdriver sockets

Double ring ratchet spanner, straight form, metric

fine-toothed SW10x13mm, SW17x19mm

Combination spanner metric to DIN 3113, form A, ISO 3318, ISO 7738, jaw position 15° ring side angled 15°, SW 6 7 8 9 10 11 12 13 14 15 16 17 18 19 21

Hexagon socket set, ball point, long, 9 pcs. 1.5-10mm

Hex key L-wrench set TX. long, 9 pcs. T10-50

Screwdriver slotted 3mm 0.5x75mm, 4mm 0.8x100mm

5.5 1x100mm, 6,5mm 1,2x100mm,

Screwdriver slotted, with impact cap 6.5mm 1.2x100mm

Phillips PH1 L80mm, PH2 L100mm

Phase tester, integrated glow lamp and series resistor for networks from 105- max. 250V

Combination pliers 180 mm, gripping zones for flat and round material, 2-component handle, hand-friendly power transmission

Water pump pliers, 7-position adjustable, polished head and joint, 2-component handle, hand-friendly power transmission

Locksmith's hammer 300g

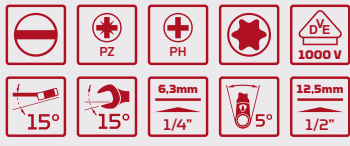



## R6900 3061

### 1/2" SOCKET SET

61 pieces

> Ideal for all jobs for do-it-yourselfers

Code	No.	Length mm	Width mm	Height mm	Pieces	Weight kg
3300370	R69003061	452	340	86	61	7,14

#### Contents

R61000806 Socket insert 1/2 hexagon  
8 9 10 11 12 13 14 15 16 17 19 21 22 24 mm | 38 mm  
R60000027 2C-Reversible ratchet 1/2 L.250 mm Return angle 5°  
R65300012 Cardan joint 1/2 L.66 mm  
R61021612 Spark plug insert 1/2 16 18 21 mm | 65 mm  
R65100024 Plug-in extension 1/2 L.125 250 mm  
R57300008 Enlargement piece 3/8 x 1/2 square L.44 mm  
R28100010 Water pump pliers 10" 7-way  
R28302180 Combination pliers L.180 mm 2C-handle  
R36605008 Offset screwdriver set hexagonal 1.5-8 mm 8 pcs  
R36405008 Offset screwdriver set TX9-40 8 pcs  
R92100020 Engineer's hammer 500g L.320 mm ash  
R09100060 Combination wrench 6 7 8 9 10 11 12 13 14 15 16 17 18 19 mm  
R38100315 2C-Screwdriver slot 3 mm  
0.5x75 mm, 5.5 mm 1x100 mm, 8 mm 1,2x100 mm  
R38200115 2C-Screwdriver PH1 L.80 mm, PH2 L.100 mm  
R38120001 MOTORCYCLE Voltage tester 3-48 V



## R4900 3016

### SOCKET SET 1/4"

16 pieces

> For hand-operated applications



Code	No.	Contents	Length mm	Width mm	Height mm	Pieces	Weight kg
3300050	R49003016	1/4" 2C lever reversible ratchet, fine-toothed, 72 teeth   150 mm 1/4" Socket hexagon 4 4,5 5 5,5 6 7 8 9 10 11 12 13   25 mm 1/4" Socket extension 100 mm, 1/4" Sliding T-bar with slider   115 mm Bit adaptor 1/4" square x 1/4" hexagon   25 mm	190	115	54	16	0,62

## R4900 3046

### SOCKET SET 1/4"

46 pieces

> For hand-operated applications

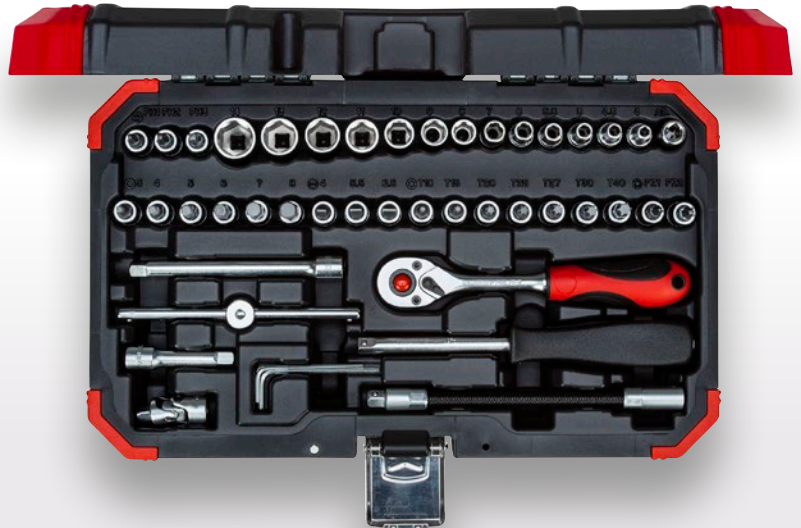

Code	No.	Length mm	Width mm	Height mm	Pieces	Weight kg
3300052	R49003046	298	185	54	46	1,414

#### Contents

1/4" 2C reversible lever ratchet fine-toothed, 72 teeth | 150 mm, 1/4" square socket 165 mm, 1/4" socket hexagon 4 4.5 5 5.5 6 7 8 9 10 11 12 13 14 | 25 mm  
 1/4" screwdriver bit socket hexagon socket inner 3 4 5 6 | 37 mm, 1/4" screwdriver bit socket slot 4 5 5.5 6 5 | 37 mm, 1/4" Screwdriver bit socket Phillips PH 1 2 3 | 37 mm  
 1/4" Screwdriver bit socket PZ 1 2 | 37 mm, 1/4" Screwdriver bit socket TX T15 T20 T25 T30 | 37 mm, 1/4" Socket wrench extension 50 100 mm  
 1/4" Cardan joint | 32 mm Bit-Adapter, 1/4" square x 1/4" hexagon | 25 mm

## R4600 3100

### 1/4" + 1/2" SOCKET SET

100 pieces

> Ideal for all screwdriving tasks during maintenance, in the trade or in the workshop



Code	No.	Length mm	Width mm	Height mm	Pieces	Weight kg
3300063	R46003100	348	365	105	100	10

#### Contents

1/4" 2C lever reversible ratchet, fine-toothed, 72 teeth | 150 mm  
 1/4" square plug-in handle 165 mm  
 1/4" socket hexagon 4 4.5 5 5.5 6 7 8 9 10 11 12 13 mm  
 1/4" socket extension 50 100 mm  
 1/4" sliding T-bar with slider | 115 mm  
 1/4" universal joint | 32 mm Bit adapter  
 1/4" sq. x 1/4" hex | 25 mm  
 1/4" bits in-hex 3 4 5 6 8 10 | 25 mm  
 1/4" bits slotted 4 5.5 7 | 25 mm  
 1/4" bits cross-head PH 1 2 3 4 | 25 mm  
 1/4" bits cross-head PZ 1 2 3 | 25 mm  
 1/4" bits TX T8 T10 T15 T20 T25 T27 T30 T40 | 25 mm  
 1/2" 2C lever reversible ratchet, fine-toothed, 72 teeth | 250 mm  
 1/2" socket hex  
 10 11 12 13 14 15 16 17 18 19 20 21 22 23 24 26 27 28 30 32 mm  
 1/2" socket extension 125 250 mm  
 1/2" universal joint | 65 mm  
 Socket extension piece/slider 3/8" x 1/2" | 44 mm  
 Combination spanners 8 9 10 11 12 13 14 15 16 17 18 19 mm  
 Hexagon Allen key set 1.5 2 2.5 3 4 5 6 8 10 mm  
 Adjustable spanner 10" 250 mm  
 Screwdriver slotted 4 5.5 6.5  
 Screwdriver cross-head PH 1 2 3  
 Side cutter 180 mm  
 Telephone pliers 200 mm  
 Water pump pliers 10" 250 mm  
 Hammer 500 g





## R4600 3092

### 1/4" + 1/2" SOCKET SET

92 pieces

> Ideal for all jobs with maintenance work, for trades people or in the workshop



Code	No.	Length mm	Width mm	Height mm	Pieces	Weight kg
330062	R46003092	383	280	83	92	5,85

#### Contents

1/4" 2C-Lever Change reversible ratchet fine-toothed, 72 teeth | 150 mm  
 1/4" Square plug-in handle | 165 mm  
 1/4" Socket 4 4.5 5 5.5 6 7 8 9 10 11 12 13 mm  
 1/4" Socket 4 5 6 7 8 9 10 11 12 13 mm | 50 mm  
 1/4" Socket extension 50 100 mm  
 1/4" Sliding T Bar | 115 mm  
 1/4" Universal joint | 32 mm  
 Bit holder 1/4" hexagonal x 1/4" hexagonal, with magnet | 60 mm  
 Bit adaptor 1/4" square x 1/4" hexagon | 25 mm  
 Drive adaptor 1/4" hexagon x square with ball lock | 25 mm  
 1/4" Bits hexagon socket 3 4 5 6 8 10 | 25 mm  
 1/4" Bits slotted 4 5 5.7 | 25 mm  
 1/4" Bits PH 0 1 2 3 4 | 25 mm  
 1/4" Bits PZ 1 2 3 | 25 mm  
 1/4" Bits TX T8 T10 T15 T20 T25 T27 T30 T40 | 25 mm  
 5/16" Bits TX T45 T50 T55 | 30 mm  
 1/2" 2C-Lever reversible ratchet fine-toothed, 72 teeth | 250 mm  
 1/2" Socket  
 10 11 12 13 14 15 17 19 22 24 27 30 32 mm  
 1/2" Spark plug socket 21 mm (13/16") | 65 mm  
 1/2" Socket extension 125 250 mm  
 1/2" Universal joint | 65 mm  
 Adaptor 3/8" x 1/2" | 44 mm  
 Bit adaptor 1/2" square x 5/16" hexagon | 38 mm  
 Double-jointed spanner 8x9 10x11 12x13 14x15 mm  
 Combination spanner 8 10 12 13 14 17 mm  
 Offset screwdriver hexagon 1.5 2 2.5 mm





**R4600 3232**

**1/4"+1/2" SOCKET SET**

232 pieces

> Ideal for all jobs for tradespeople or in the workshop

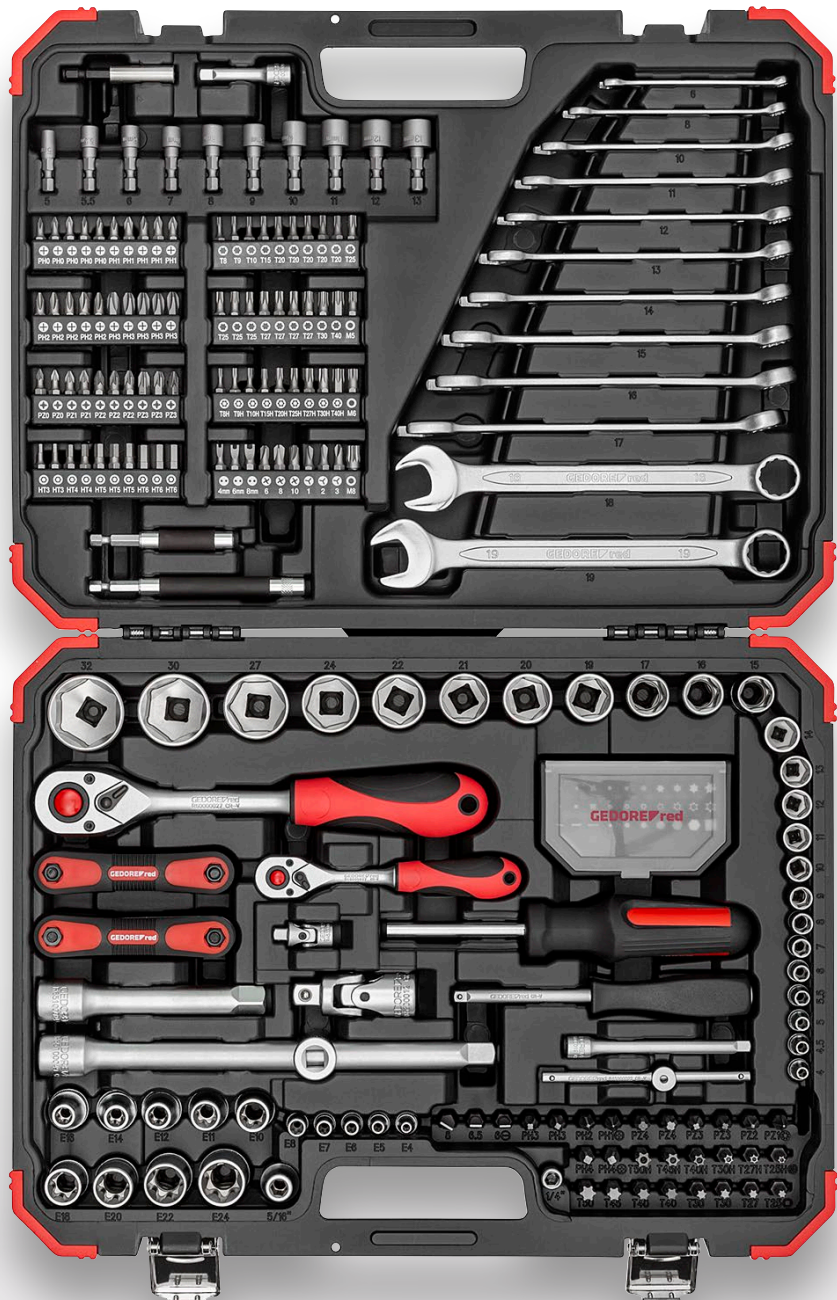

Code	No.	Length mm	Width mm	Height mm	Pieces	Weight kg
3300185	R46003232	452	340	86	232	8,9

**Contents**

2C-1/4" Reversible ratchet length 150 mm Return angle 5°, 2C-1/2" Reversible ratchet length 250 mm Return angle 5°  
 1/4" Sockets 4 4.5 5 5.5 6 7 8 9 10 11 12 13 14 | 25 mm, 1/2" Sockets 15 16 17 19 20 21 22 24 | 38 mm  
 1/2" Sockets 27 30 32 | 42 mm, 1/4" T-handle with slider  
 1/4" Socket extension 50 100 mm, 1/2" Socket extension 125 - 250 mm  
 1/4" Universal joint length 33 mm, 1/2" Universal joint length 66 mm, 1/4" Square socket handle 165 mm, 1/4" Sockets TX E4 E5 E6 E7 E8 | 25mm  
 1/2" Sockets TX E10 E11 E12 E14 E16 E18 E20 | 38mm, E22 L 40mm, E24 L41mm  
 Adator 3/8" x 1/2", 1/2" Bit adaptor square x 5/16" hexagon  
 1/4" Bit screwdriver L 100 mm, 1/4" Bits 25 mm long: Hexagon socket 3 4 5 6, PH 5x 0 1 2 3 each, PZ 2x 0 1 each 3x 2 3, TX T8 T9 T10 T15 T20 T25 T27 T30 TXB T40 T9 T10 T15 T20 T25 T27 T30 T40 Spanner 5 6 8 XZN 4 6 8 TRI-WING 1 2 3 Torque 6 8 10  
 1/4" Bits hex 38 mm long 5 5.5 6 7 8 9 10 11 12 13 mm, 1/4" Bit holder 60+80+120mm  
 30-piece Bit box with 1/4" bits, 25 mm long: internal hexagon 2 3 4 5 5.5 6 mm, slot 4 5.5 6 mm, PH 1 2 3, PZ 1 2 3, TX T10 T15 5xT20 4xT25 4xT27 T30 T40, TXB T10 T15 T20 T25 T27 T30 T40  
 5/16" Bits 30 mm long: slotted 6 6.5 8, PH 1 2 2x3 4 each, PZ 1 2 2x3 4 each, TX T25 T27 T30 T40 T45 T50, TXB T 25 T27 T30 T40 T5 T45  
 Combination wrench 6 8 10 11 12 13 14 15 16 17 18 19 mm, Offset screwdriver 1.5 2.5 3 4 5 6 8 mm  
 Offset screwdriver TX T9 T10 T15 T20 T25 T27 T30 T40, Insert holder 1/4" square x 1/4" hex length 25mm

## R4560 3172

### 1/4" + 3/8" + 1/2" SOCKET SET

172 pieces

> Ideal for all jobs with maintenance work,  
for trades people or in the workshop

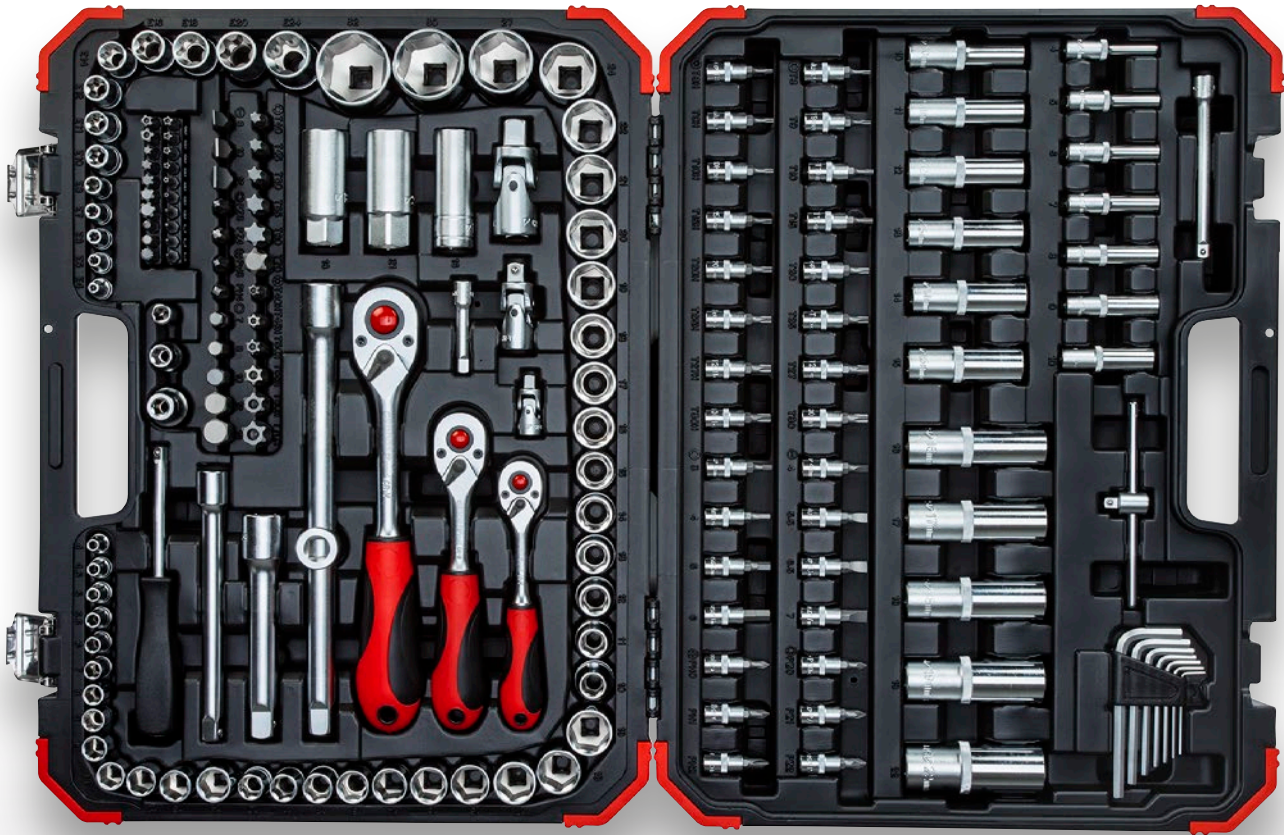

Code	No.	Length mm	Width mm	Height mm	Pieces	Weight kg
3300058	R45603172	450	345	93	172	10,5

#### Contents

1/4" 2C lever reversible ratchet, fine-toothed, 72 teeth | 150 mm, 1/4" square plug-in handle 165 mm, 1/4" socket wrench insert, hexagon SW 4 4.5 5 5.5 6 7 8 9 10 11 12 13 14 | 25 mm  
1/4" socket wrench insert hexagon SW 4 5 6 7 8 9 10 | 50 mm, 1/4" socket wrench insert TX E4 E5 E6 E7 E8 | 25 mm  
1/4" screwdriver bit socket hexagon socket 3 4 5 6 | 37 mm, 1/4" screwdriver bit socket slotted 4.5 5 6.5 7 | 37 mm  
1/4" screwdriver bit socket cross-slotted PH 0 1 2 | 37 mm, 1/4" screwdriver bit socket cross recess PZ 0 1 2 | 37 mm  
1/4" screwdriver bit socket TX T8 T9 T10 T15 T20 T25 T27 T30 | 37 mm, 1/4" screwdriver bit socket TX with bore T8 T9 T10 T15 T20 T25 T27 T30 | 37 mm  
1/4" socket wrench extension 50 100 mm 1/4" T-handle with slider | 115 mm, 1/4" universal joint | 32 mm bit adapter 1/4" square x 1/4" hex. | 25 mm  
1/4" bits TX T5 T6 T7 | 25 mm, 1/4" bits TX with hole T7 | 25 mm, 1/4" bits TX plus security T10 T15 T20 T25 T27 T30 T40 T45 | 25 mm  
1/4" bits multi-tooth XZN M5 M6 M8 | 25 mm, 1/4" bits keyway M5 M6 M7 M8 M9 | 25 mm  
5/16" bits hexagon socket 7 8 10 12 14 | 30 mm, 5/16" bits slotted 8 10 12 | 30 mm, 5/16" bits cross recess PH 3 4 | 30 mm, 5/16" bits cross recess PZ 3 4 | 30 mm  
5/16" bits TX T40 T45 T50 T55 T60 T70 | 30 mm, 5/16" bits TX with bore T40 T45 T50 T55 T60 T70 | 30 mm, 3/8" 2C lever reversible ratchet, fine-toothed, 72 teeth | 180 mm  
3/8" socket wrench insert hexagon SW 10 11 12 13 14 15 16 17 18 19, 3/8" socket wrench insert hexagon SW 10 11 12 13 14 15 | 63 mm, 3/8" socket wrench insert TX E10 E11 E12 E14 E16 E18  
3/8" spark plug insert SW 18 mm | 65 mm, 3/8" socket wrench extension 150 mm, 3/8" universal joint | 49 mm bit adapter, 3/8" square x 5/16" hex | 30 mm  
1/2" 2C lever reversible ratchet, fine-toothed, 72 teeth | 250 mm, 1/2" socket wrench insert hexagon SW 10 11 12 13 14 15 16 17 18 19 20 21 22 24 27 30 32  
1/2" socket wrench insert 6-kant SW 16 17 18 19 22 | 77 mm, 1/2" socket wrench insert TX E20 E24, 1/2" spark plug insert SW 16 21 mm | 65 mm  
1/2" socket wrench extension 125 250 mm, 1/2" universal joint | 66 mm, enlarging piece / sliding piece 3/8" x 1/2" | 44 mm  
bit adapter 1/2" square x 5/16" hex | 38 mm, offset screwdriver set hexagon SW 1.5 2.2 5 3 4 5 6 mm



## R7800 4014

### SOCKET SET 3/4"

14 pieces

> For hand-operated applications



Code	No.	Contents	Length mm	Width mm	Height mm	Pieces	Weight kg
3300011	R78004014	3/4" reversible ratchet, coarse-cogged, 24 teeth   510 mm 3/4" socket hexagon 22 24 27 30 32 36 38 41 46 50 mm 3/4" socket extensions 200 - 400 mm, 3/4" sliding T-bar with slider   460 mm	552	548	105	14	14,2

## R6304 3003

### 1/2" IMPACT SOCKET SET

3 pieces

- > Specially for fitting / removing wheels of vehicles
- > Plastic sleeves for damage-free work on aluminium wheel rims
- > Colour coding for ease in identifying the right size
- > Square drive as per DIN 3121 - G 12,5, ISO 1174
- > Design according to DIN 3129, ISO 2725-2
- > Machine-operated, fixing with safety ring / pin



Code	No.	Length mm	Width mm	Height mm	Pieces	Weight kg
3300578	R63043003	158	135	52	3	0,83

#### Contents

Impact socket 17 19 21 mm | 86 mm

## R6300 3008

### IMPACT SOCKET SET 1/2"

8 pieces

- > Machine-operated, fixing with safety ring / pin
- > Square drive as per DIN 3121 - G 12,5, ISO 1174
- > Design according to DIN 3129, ISO 2725-2

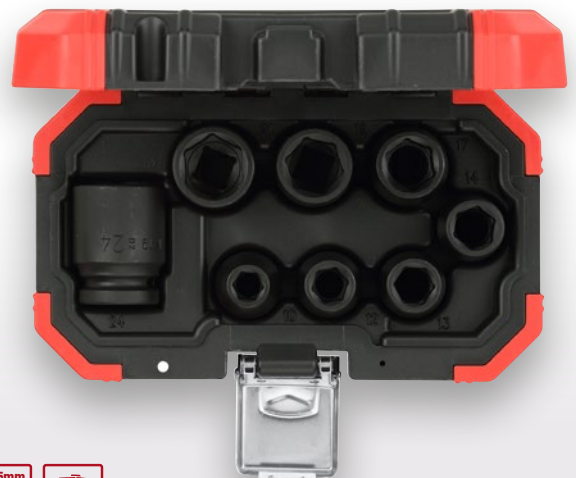

Code	No.	Length mm	Width mm	Height mm	Pieces	Weight kg
3300575	R63003008	190	110	52	8	1,1

#### Contents

Impact socket 10 12 13 14 17 19 21 24 mm

## R6800 3030

### SET OF SCREWDRIVER INSERTS 1/2" IN

30 pieces

- > For hand-operated applications
- > Long version



Code	No.	Length mm	Width mm	Height mm	Pieces	Weight kg
3301573	R68003030	425	325	56	30	5,4

#### Contents

Screwdriver bit socket in-hex, 5 6 7 8 10 12 14 17 19 | 55 mm  
Screwdriver bit socket, in-hex 5 6 7 8 10 11 12 13 | 100 mm  
Screwdriver bit socket in-hex 5 6 7 8 10 12 14 | 140 mm  
Screwdriver bit socket in-hex, 5 6 7 8 10 12 | 200 mm

## R6800 3032

### SET OF SCREWDRIVER SOCKETS 1/2" TX

32 pieces

- > For hand-operated applications
- > Long version



Code	No.	Length mm	Width mm	Height mm	Pieces	Weight kg
3301577	R68003032	425	325	56	32	5,4

#### Contents

Screwdriver bit socket TX T20 T25 T27 T30 T40 T45 T50 T55 T60 T70 | 55 mm  
Screwdriver bit socket TX T20 T25 T27 T30 T40 T45 T50 T55 T60 T70 | 100 mm  
Screwdriver bit socket TX T40 T45 T50 T55 T60 T70 | 140 mm  
Screwdriver bit socket TX T40 T45 T50 T55 T60 T70 | 200 mm

## R6800 3075

### ASSEMBLY TOOL SET TX 1/4" + 1/2"

75 pieces

- > For hand-operated screw work



Code	No.	Length mm	Width mm	Height mm	Pieces	Weight kg
3301575	R68003075	383	272	80	75	3,5

#### Contents

1/4" socket TX E4 E5 E6 E7 E8 E10 E11 | 25 mm, 1/4" screwdriver bit socket TX T7 T8 T9 T10 T15 T20 T25 T27 T30, T40 | 37 mm, 1/4" bit adaptor square x hex | 25 mm  
1/4" bits TX with hole T7 T8 T9 T10 T15 T20 T25 T27 T30 T40 | 25 mm, 1/2" socket TX E12 E14 E16 E18 E20 E22 E24, Bit adaptor 1/2" 4kt x 10 mm 6kt | 38 mm 10mm  
bits TX T40 T45 T50 T55 T60 | 30 mm 10mm, bits TX T15 T20 T25 T30 T40 T45 T50 T55 T60 | 75 mm, Screwdriver TX T8x60 T10x80 T15x80 T20x100 T25x100 T27x125 T30x125 T40x150 mm  
Double-ended ring spanner TX E6xE8 E10xE12 E14xE18 E20xE24, Hexagon socket key TX T8 T10 T15 T20 T25 T27 T30 T40 T45 T50 T55 T60, Telescopic magnetic lifter with scriber 126 - 636 mm

## R6890 3011

### WHEEL MOUNTING SET

11 pieces

- > The universal wheel mounting set impresses with precision and flexibility
- > Includes torque wrenches for cars /SUVs/vans with 40-200 Nm



Code	No.	Contents	Length mm	Width mm	Height mm	Pieces	Weight kg
3300400	R68903011	1/2" 2C-Telescopic ratchet 460-600 mm, 1/2" Socket extension 75 mm + 125 mm 1/2" Impact sockets, hexagon with protective sleeve 17 mm + 19 mm Tyre tread depth gauge red/black, Magnetic dish White tyre marking chalk, Wheel bolt bag red/black Blow-moulded storage case (520x280x100mm), Torque wrench 1/2" 40 - 200 Nm	540	290	145	11	5,7

## R2170 2013

### ON THE ROAD BIKE SET

13 pieces

- > Ergonomic handling with bit ratchet and bit adapter
- > Selection of bits and sockets tailored to the screws and nuts on a bike
- > Clampable bag on the saddle and seat post



Code	No.	Length mm	Width mm	Height mm	Pieces	Weight kg
3300194	R21702013	90	54	145	13	0,24

#### Contents

Tyre lever set, 3 pieces, Bit hexagon socket 3 4 5 6, Bit PH1, Bit TX T25  
Socket 10 mm, Ratchet 1/4", Drive adaptor  
Bit holder with quick release system 66.5 mm, Pocket



R2165 2057

# TOOL CASE AZUBI L

57 pieces

- > Basic assortment for the most common applications such as screwing, loosening, cutting and measuring
- > Very robust case, pressure-, dust- and waterproof, also suitable for air travel
- > The 2 built-in gas struts hold the case open and prevent it from closing suddenly
- > Increased storage space thanks to tool compartments including pockets for improved organisation
- > Reinforced fastening eyelets for all types of padlocks

57-piece  
assortment  
for trainees



Sturdy and  
water-tight case

Maximum overview and  
effortless tool access

Code	No.	Contents	Length mm	Width mm	Height mm	Pieces	Weight kg
3301638	R21652057	Socket set 1/4", 33 pieces 4-13 mm 2C-Screwdriver slotted 3 4 5,5 mm 2C-Screwdriver PH1 PH2 Combination wrench set, 12 pieces 6-22 mm Wood sectioned folding ruler 2 m Class III 2C-Combination pliers 180 mm 2C-Side cutter 160 mm Water pump pliers 10", 7-way adjustable Spirit level 300 mm Engineer's hammer 300 g, 300 mm ash	485	212	414	57	10,82



R2165 2101

# MASTER TOOL CASE XL

101 pieces

- > Complete tradesperson assortment for screwing, loosening, cutting, measuring and many more jobs and challenges on the building site
- > Ergonomic 2C carrying handle ensures easy and relaxed tool transport
- > The 2 integrated gas pressure springs keep the case open and protect it from sudden closing
- > Extra storage space with tool panels, including insert bag for clearer overview
- > Strengthened lugs for every kind of padlock

101-piece assortment  
for construction and  
maintenance work



Maximum  
overview  
and effortless  
tool access

Sturdy and  
water-tight case

Code	No.	Contents	Length mm	Width mm	Height mm	Pieces	Weight kg
3301639	R21652101	Bit-Box 1/4" 32 pieces, slot PH PZ TX hexagon Socket set 1/4", 46 pieces 4-14 mm Combination ratchet spanner set 5 pieces 8-19 mm 2C-Bit screwdriver 1/4" 100 mm, 2C-Screwdriver slotted 4 5,5 6,5 mm 2C-Screwdriver PH1 PH2, 2C-Screwdriver PZ1 PZ2 Voltage tester 220-250V slot 3,5 mm 2C-Combination pliers 180 mm, 2C-Power side cutter 180 mm Water pump pliers 10", 7-way adjustable, Flat chisel flat oval 200 x 24 x 13 mm Spatula 60 mm, Wood sectioned folding ruler 2 m Class III Spirit level 300 mm, Engineer's hammer 300 g, 300 mm ash	485	212	414	101	11,85



R2190 2124

# TOOL TROLLEY MEISTER XXL

124 pieces

- > Complete range of tools for all common applications
- > Robust, dust and waterproof tool trolley equipped with 2 smooth-running castors and snap-in telescopic handle for easy transport of tools
- > The 2 built-in gas struts hold the case open and prevent it from closing suddenly
- > Increased storage space thanks to tool trays incl. pockets for improved organisation of the tools
- > Reinforced fastening eyelets for all types of padlocks



Sturdy and water-tight case with gas pressure springs

124 tools for construction and maintenance work

Extensive equipment with maximum overview



Code	No.	Length mm	Width mm	Height mm	Pieces	Weight kg
3301641	R21902124	550	225	350	124	14,12

#### Contents

Bit-Box 1/4" 32 pieces, slot PH PZ TX hexagon, Socket set 1/4", 46 pieces 4-14 mm, Combination ratchet spanner set, 5 pieces 8-19 mm  
2C-Bit screwdriver 1/4" 100 mm, 2C-Screwdriver slotted 3 4 5,5mm, 2C-Screwdriver PH1 PH2, 2C-Screwdriver PZ1 PZ2, 2C-Screwdriver TX T15 T20 T25 T27  
Offset screwdriver set, 9 pieces TX T10-T50, Offset screwdriver set, 9 pieces hex 1,5-10 mm, Voltage tester 220-250V slot 3,5 mm  
2C-Power side cutter 200 mm, 2C-Combination pliers 200 mm, Water pump pliers 10", 7-way adjustable, Flat chisel flat oval 200x24x13mm  
Spatula 60 mm, Utility knife 18 mm, Wood sectioned folding ruler 2 m Class III, Engineer's hammer 500g 320mm ash

R2190 2072

# PLUMBERS TOOL TROLLEY

72 pieces

- > 72-piece tool assortment for all standard work in the plumbing, heating and air-con area
- > For mobile use, and for air transport
- > Sturdy, dust and water-tight tool trolley
- > Lockable with padlocks
- > Strengthened lugs for every kind of padlock
- > The 2 integrated gas pressure springs keep the case open and protect it from sudden closing



Extensive equipment with maximum overview

Sturdy and water-tight case with gas pressure springs

72 tools for sanitation-  
heating-air conditioning



Code	No.	Length mm	Width mm	Height mm	Pieces	Weight kg
3301644	R21902072	550	225	350	72	14,97

#### Contents

Socket set 1/4", 33 pieces 4-13 mm, Screwdriver VDE PH1 PH2, Screwdriver VDE PZ1 PZ2, Screwdriver VDE slot 3x0.5x100 4x0.8x100 5.5x1x125  
Offset screwdriver set, 9 pieces TX T10-T50, Offset screwdriver set, 9 pieces hexagon 1,5-10 mm, Voltage tester 220-250V slot 3,5mm  
2C-Side cutter VDE 180 mm, Pipe cutter copper pipe-Ø 3-35 mm, Pipe wrench 1.1/2" 420 mm, Pliers wrench 10", Water pump pliers 10", 7-way adjustable  
Flat chisel flat oval 250x25x13mm, Spatula 60 mm, Utility knife 18 mm  
Hacksaw 150 mm, Wood sectioned folding ruler 2 m Class III, Spirit level 300 mm, Engineer's hammer 500 g 320 mm ash

R2165 2089

# TOOL CASE ELECTRICIAN

89 pieces

- > Practical selection of tools for numerous installations on different systems (electrical)
- > Extremely sturdy case, pressure, dust and water-tight, also ideal for air travel
- > Optimum overview and access to the tool, sudden case closing prevented with gas pressure springs
- > Extra-big storage space and clearer overview with tool panels including insert bag
- > Lockable with padlocks

89 tools for working  
on electrical systems

Extensive  
equipment  
with maximum  
overview



Sturdy and water-tight case  
with gas pressure springs



Code	No.	Length mm	Width mm	Height mm	Pieces	Weight kg
3301643	R21652089	485	212	414	89	12,54

#### Contents

Bit-Box 1/4" 32 pieces, slot PH PZ TX hexagon, Socket set 1/4", 33 pieces 4-13 mm, Combination ratchet spanner set, 5 pieces 8-19 mm  
2C-Bit screwdriver 1/4" 100 mm, Screwdriver VDE slot 3x0.5x100 4x0.8x100 5,5x1x125, Screwdriver VDE PH1 PH2, Screwdriver VDE PZ1 PZ2  
Voltage tester 220-250V slot 3,5mm, 2C-Side cutter VDE 180 mm, 2C-Telephone plier VDE 200 mm 45°, Wire stripper StrippMax-Auto  
Water pump pliers 10", 7-way adjustable, Spatula 60 mm, Utility knife 18 mm, Wood sectioned folding ruler 2 m Class III, Spirit level 300 mm, Engineer's hammer 300 g 300 mm ash



## R6011 0009

### 2C-1/2" SWIVEL-HEAD TELESCOPIC RATCHET

reversible

- > Ratchet head swivels through 180°
- > Ring for reversing clockwise/anticlockwise direction
- > For sockets, accessories etc. with square drive as per DIN 3120 - C 12,5, ISO 1174, with ball retention groove

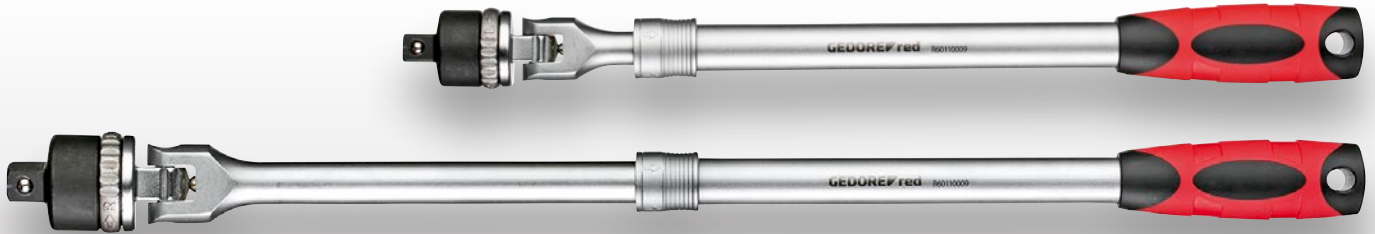

Code	No.	Square drive inch	Square drive mm	variable length mm	Return angle	Number of teeth	Weight kg
3300523	R60110009	1/2"	12,5	430-580	10°	36	1,292

## R38XO 2006

### SCREWDRIVER-SETS

- > Driven tips phosphated, corrosion-protected and low-wear
- > 2-component-handle for a hands-friendly transfer of force
- > 5-sided grip heads prevent rolling away



Code	No.	Pieces	Weight kg
3301270	R38002006	6	0,435

#### Contents

Screwdriver slotted 3 5.5 6.5 mm, Screwdriver PH 0 1 2

Code	No.	Pieces	Weight kg
3301272	R38402006	6	0,55

#### Contents

TX screwdriver T10 T15 T20 T25 T30 T40





## RX890 XXXX

### TORQUE WRENCHES

5-300 Nm

- > Adjustable torque wrench with square drive and integrated ratchet function
- > Audible Torque triggering can clearly be heard and felt
- > Right-hand and left-hand tightening by changing the mushroom head / push-through square
- > Tripping accuracy: +/-3 % tolerance of the set scale value

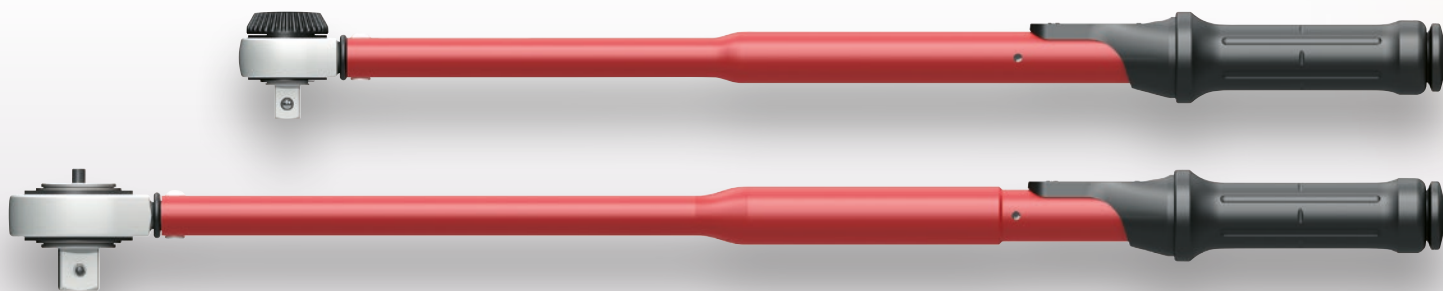

Code	No.	Type	Square drive inch	Square drive metric mm	Nm	vernier Nm	Height mm	Housing - square centre spacing mm	Length mm	Head width mm	Head height mm	Weight kg
<b>3301214</b>	R48900025	square socket with knob, serrated	1/4"	6,3	5-25	0,1	34	17,5	285	35,0	25,3	0,515
<b>3301871</b>	R58900050	square socket with knob, serrated	3/8"	10	10-50	0,25	34	17,5	330	35,0	25,3	0,476
<b>3301216</b>	R68900100	square socket with knob, serrated	1/2"	12,5	20-100	0,5	45	22	395	46,0	35,9	1,176
<b>3301217</b>	R68900200	square socket with knob, serrated	1/2"	12,5	40-200	1	45	22	485	46,0	35,9	1,42
<b>3301218</b>	R68900300	square socket with knob, serrated	1/2"	12,5	60-300	1	47	23	575	46,0	35,9	1,541

R3660 1009 / R3640 1009

# ALLEN KEY SET WITH COLOUR CODING

9 parts, long

The right  
size in a jiffy

Offset and  
straight screwing  
with two heads



Comfortable working  
with long handle

**R3660 1009**

## ALLEN KEY SET HEX WITH COLOUR CODING

9 parts, long

- > Colour coded plastic coating to find the right L-key faster
- > Round shape
- > Long version with ball end
- > Folding holder with belt clip



**R3640 1009**

## ALLEN KEY SET TX WITH COLOUR CODING

9 parts, long

- > Colour coded plastic coating to find the right L-key faster
- > Round shape
- > Long version
- > Folding holder with belt clip



Code	No.	Contents	Pieces	Weight kg
3301332	R36601009	1.5 2 2.5 3 4 5 6 8 10 mm	9	0,6

Code	No.	Contents	Pieces	Weight kg
3301333	R36401009	T10 T15 T20 T25 T27 T30 T40 T45 T50	9	0,52

R2015 2205

# WORKSHOP TROLLEY GEDWORKER

with 5 drawers

- > Sheet steel, corrosion-resistant and scratch-resistant powder-coated
- > Working platform with cover made of ABS plastic with 3 compartments for small parts
- > Central locking system
- > Ball-bearing guide rails
- > All drawers can be pulled out on both sides
- > Load capacity per drawer 20 kg
- > Additional storage compartment for larger items below the last drawer
- > The GEDORE trapezoidal axle construction secures smooth running, manoeuvrability and track-keeping also in case of maximum loads

**Compact  
organisation  
helper**

**Flexible access  
from 2 sides**

**Smooth-running  
drawers**



Made in Austria



Code	No.	RAL	Length mm	Width mm	Height mm	Drawers	Max. load-bearing capacity kg	Number of drawers	Weight kg
3301675	R20152205	9005	685	462	963	2xType 1, H=74mm 3xType 2, H=119mm	200	5	41

R2156 2005

# TOOL SET IN WORKSHOP TROLLEY GEDWORKER

119 pieces

- > As basic equipment for the workshop, basic range for beginners of all professional groups or the experienced
- > Metric dimension tools
- > Clearly arranged in GEDORE red foam modules
- > With check tool system: Completeness check using 2-colored foam inserts

**Sturdy body  
and chassis**

**Drawer access  
from two sides**

**Smooth-running and  
easy to manoeuvre,  
even when fully loaded**



Made In Austria

**Equipped version  
with 119 pieces**



Code	No.	Length mm	Width mm	Height mm	Pieces	Weight kg
3301676	R21562005	685	462	963	119	55,46

**Contents**

1/4" 2C-Lever reversible ratchet fine toothed, 72 teeth | 150 mm, 1/4" Driving handle 165 mm, 1/4" Socket hexagon 4 4,5 5 5,5 6 7 8 9 10 11 12 13  
 1/4" Screwdriver bit socket for in-hex screws 3 4 5 6 8 10 | 37 mm, 1/4" Screwdriver bit socket slot 5,5 6,5 | 37 mm, 1/4" Screwdriver bit socket PH 1 2 3 | 37 mm  
 1/4" Screwdriver bit socket PZ 1 2 | 37 mm, 1/4" Screwdriver bit socket TX with hole T10 T15 T20 T25 T27 T30 T40 | 37 mm, 1/4" Extension 100 mm  
 1/4" Sliding T-bar with slider | 115 mm, 1/4" Universal joint | 32 mm, 1/2" 2C-Lever reversible ratchet fine toothed, 72 teeth | 250 mm, 1/2" Extension 125 250 mm  
 1/2" Sliding T-bar with slider 250 mm, 1/2" Universal joint | 66 mm, 1/2" Socket hexagon 10 11 12 13 14 15 16 17 18 19 21 22 23 24 26 27 28 30 32  
 1/2" Screwdriver bit socket for in-hex screws 6 7 8 9 10 12 14 | 55 mm, Screwdriver slotted 4 5,5 6,5 8 mm, Screwdriver PH 1 2, Screwdriver T10 T15 T20 T25 T30 T40  
 Combination spanner 6 7 8 9 10 11 12 13 14 15 16 17 18 19 21 22 24 mm, Hexagon socket 1,5 2 2,5 3 4 5 6 8 10 mm, Engineer's hammer 300 g, Flat chisel 125 mm 150 mm  
 Cross cut chisel 125 mm, Centre punch 4 mm | 120 mm, Pin punch 4 mm | 120 mm, Drift punch 3 mm | 150 mm, Water pump pliers 10" | 250 mm  
 Combination pliers 180 mm, Telephone plier, gerade 160 mm, Side cutter 160 mm, Utility knife with 5 spare blades, Measuring tape 3 m

R2020 2207

# WORKSHOP TROLLEY GEDMASTER

with 7 drawers

- > Sheet steel, corrosion-resistant and scratch-resistant powder-coated
- > Working platform with cover made of ABS plastic with 4 compartments for small parts
- > Side panels with Euro perforation 10 x 38 mm for attaching accessories
- > Central locking with cylinder lock
- > Each drawer with safety locking, single-hand operation
- > All drawers with full extension and ball bearing guide rails
- > Load capacity per drawer 40 kg
- > The GEDORE trapezoidal axle construction secures smooth running, manoeuvrability and track-keeping also in case of maximum loads

**Compact  
organisation  
helpers in the lid**

**400 kg load  
bearing capacity**



**7 drawers**



Made in Austria



Code	No.	RAL	Length mm	Width mm	Height mm	Drawers	Max. load-bearing capacity kg	Number of drawers	Weight kg
3301677	R20202207	9005	790	470	999	5xType 1, H=70mm 2xType 2, H=145mm	400	7	65

R2207 1005

# TOOL SET IN WORKSHOP TROLLEY GEDMASTER

273 pieces

- > Extensive range for industry, trade, automotive and the advanced do-it-yourselfer
- > Metric dimension tools
- > Clearly arranged in GEDORE red foam modules
- > With check tool system: Completeness check using 2-colored foam inserts

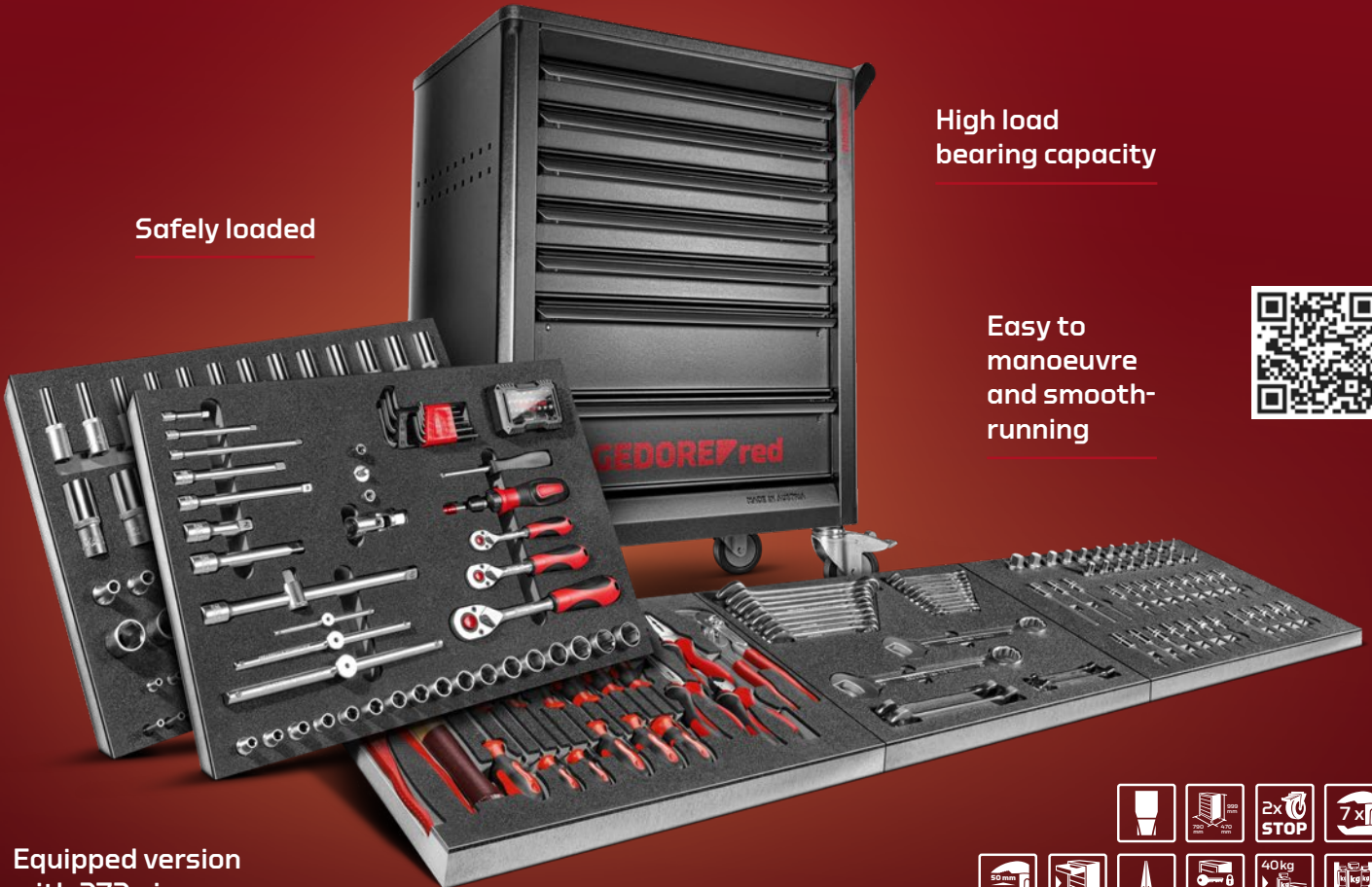

Safely loaded

High load bearing capacity

Easy to manoeuvre and smooth-running



Equipped version with 273 pieces

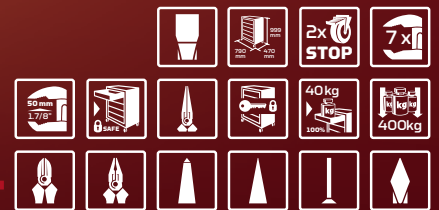

Made in Austria

Code	No.	Length mm	Width mm	Height mm	Pieces	Weight kg
3301678	R22071005	790	470	999	273	88,5

## Contents

Tool trolley GEDMaster 7 drawers, 1/4" 2C-Reversible ratchet L.150mm, 1/4" Extension L.50mm, 1/4" Extension L.100mm, 1/4" Extension L.150mm  
 1/4" Sliding T-bar with slider L.115mm, 1/4" Universal joint L.33mm, 1/4" Driving handle L.62mm 2C-handle, 1/4" Bit-Adapter square x hexagon L.24.7mm  
 1/4" Bit-Box SL+PH+PZ+TX+hexagon 32 pcs, 1/4" Ratchet screwdriver with telescopic blade, 3/8" 2C-Reversible ratchet L.180mm, 3/8" Socket hexagon 6 7 8 9 10 11 12 13 14 15 16 17 18 19 20 21 22  
 3/8" Extension L.125mm, 3/8" Extension L.150mm, 3/8" Sliding T-bar with slider, Converter 3/8" x 1/2" square L.44mm, Reducer 3/8" to 1/4",  
 1/2" 2C-Reversible ratchet L.250mm, 1/2" Universal joint L.66mm, 1/2" Extension L.75mm, 1/2" Extension L.125m, 1/2" Extension L.250mm  
 1/2" Sliding T-bar with slider, Hexagon socket key set hexagon.5-10mm 9 pcs, 1/4" Socket hexagon 4 4.5 5 5.5 6 7 8 9 10 11 12 13 14 L.25mm  
 1/4" Socket hexagon 4 4.5 5 5.5 6 7 8 9 10 11 12 13 L.50mm, 1/4" Socket TX E5 E6 E7 E8 E10 L.25mm, 1/4" Screwdriver bit socket 3 4 5 6 L.37mm,  
 1/4" Screwdriver bit socket PH1 PH2 L.37mm, 1/4" Screwdriver bit socket PZ1 PZ2 L.37mm, 1/4" Screwdriver bit socket SC 5,5 6,5 L.37mm, 1/4" Screwdriver bit socket TX B0 T10 T15 T20 T25 T27 T30,  
 1/4" Screwdriver bit socket TX T10 T15 T20 T25 T27 T30 T40, 1/2" Socket hexagon 8 9 10 11 12 13 14 15 16 17 18 19 20 21 22 24 27 32,  
 1/2" Socket hexagon 10 11 12 13 14 15 16 17 18 19 20 21 22 24 27 30 32, 1/2" Socket TX E8 E10 E11 E12 E14 E16 E18 E20 E22 E24, 1/2" Spark plug socket 16 21  
 1/2" Screwdriver bit socket 4 5 6 7 8 9 10 11 12 14 17 19 L.55mm, 1/2" Screwdriver bit socket 5 6 7 8 10 12 14 17 L.100mm,  
 1/2" Screwdriver bit socket TX T20 T25 T27 T30 T40 T45 T50 T55 T60 L.100mm,  
 1/2" Screwdriver bit socket XZN M5 M6 M8 M10 M12 M14 M16, Combination pliers L.180mm 2C-handle, Side cutter L.160mm 2C-handle, Telephone plier straight L.200mm  
 2C-handle, 2C-Screwdriver slot 3 4 5 5 6 5, 2C-Screwdriver PH1 PH2, 2C-Screwdriver TX T10 T15 T20 T25 T30 T40, Water pump pliers 10", Engineer's hammer 300g L.300mm,  
 Drift punch octagonal 120x4mm Ø12mm, Centre punch octagonal 120x4mm Ø10mm, Pin punch octagonal 150x4mm Ø10mm, Flat chisel flat oval 125x15x9mm, Flat chisel flat oval 150x18x11mm,  
 Cross cut chisel flat oval, Pliers wrench 10", Combination spanner 6 7 8 9 10 11 12 13 14 15 16 17 18 19 20 21 22 24 27 30 32, Combination ratchet spanner 10 13 17 19

## R2040 0006

### TOOL TROLLEY MECHANIC PLUS

with 6 drawers

- > Large storage space with adjustable shelf, separately lockable
- > Strong, sheet steel construction, torsionally rigid, designed to take high loads
- > 988 x 431 mm working platform made of wood, 30 mm thick
- > 6 drawers with telescopic fully extending runners, with individual locking (one-hand operation)
- > The individual locking device - unlockable only with a practical, concealed release bar - prevents the drawer being opened when the trolley is in motion
- > Load capacity 25 kg per drawer, variable partitionable
- > 2 swivel casters Ø 100 mm of which one has a double-stop wheel lock, 2 castors Ø 140 mm, side projecting thus affording considerable stability



Code	No.	RAL	Length mm	Width mm	Height mm	Drawers	Max. load-bearing capacity kg	Number of drawers	Shelves	Worktop thickness mm	Weight kg
3301818	R20400006	3020 / 7016	988	431	935	4 x H 69 mm 1 x H 144 mm 1 x H 218 mm	210	6	1	30	81



## R2156 0004

### TOOL SET IN WORKSHOP TROLLEY MECHANIC

129 pieces

- > As basic equipment for the workshop, basic range for beginners of all professional groups or the experienced
- > Metric dimension tools
- > Clearly arranged in GEDORE red foam modules
- > With check tool system: Completeness check using 2-colored foam inserts

Code	No.	RAL	Length mm	Width mm
3301673	R21560004	3020 / 7016	628	418
Height mm	Number of drawers	Pieces	Weight kg	
910	6	129	68,1	

#### Contents

1/4" 2C-Lever reversible ratchet, fine-toothed, 72 teeth | 150 mm  
 1/4" Driving handle 165 mm  
 1/4" Socket hex 4 4,5 5 5,5 6 7 8 9 10 11 12 13 14 mm  
 1/4" Socket hex 4 4,5 5 5,5 6 7 8 9 10 11 12 13 mm | 50 mm  
 1/4" Screwdriver bit socket In-hex 3 4 5 6 8 10 | 37 mm  
 1/4" Screwdriver bit socket slot 5,5 6,5 | 37 mm  
 1/4" Screwdriver bit socket cross recess PH 1 2 3 | 37 mm  
 1/4" Screwdriver bit socket cross recess PZ 1 2 | 37 mm  
 1/4" Screwdriver bit socket TX with hole T10 T15 T20 T25 T27 T30 T40 | 37 mm  
 1/4" Socket extension 100 mm  
 1/4" Sliding T Bar | 115 mm, 1/4" Universal joint | 32 mm  
 1/2" 2C-Lever reversible ratchet, fine-toothed, 72 teeth | 250 mm  
 1/2" Socket hex 10 11 12 13 14 15 16 17 18 19 21 22 23 24 26 27 28 30 32 mm  
 1/2" Screwdriver bit socket In-hex 6 7 8 9 10 12 14 | 55 mm  
 1/2" Spark plug insert 16 21 mm | 65 mm  
 1/2" Socket extension 125 250 mm  
 1/2" Sliding T Bar | 250 mm, 1/2" Universal joint | 66 mm  
 Adjustable wrench 8" 200 mm  
 Combination ratchet spanner 8 9 10 11 12 13 14 15 16 17 18 19 20 22 mm  
 Double open ended spanner 6x7 8x9 10x11 12x13 14x15 16x17 18x19 20x22 mm  
 Combination pliers 180 mm  
 Side cutter 160 mm, Flat nose pliers, straight 200 mm  
 Screwdriver Slot 3 4 5,5 6,5 mm, Screwdriver cross recess PH 1 2  
 Screwdriver TX T10 T15 T20 T25 T30 T40, Water pump pliers 10" 250 mm  
 Engineer's hammer 300 g, Flat cold chisel 125 mm, 150 mm  
 Cross-cut chisels 125 mm, Centre punch 4 mm | 120 mm  
 Pin punch 4 mm | 120 mm, Drift punch 3 mm | 150 mm





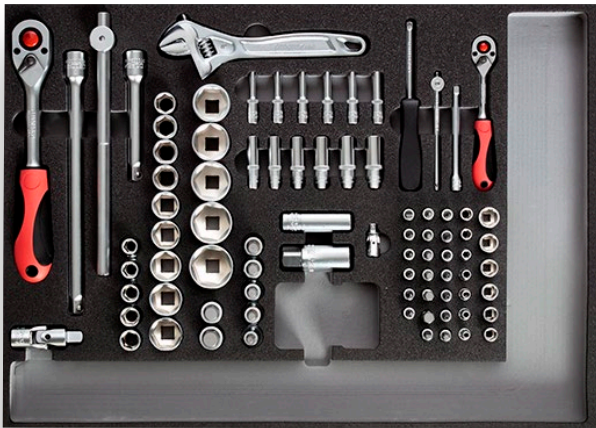

## R2207 1004

### TOOL SET IN WORKSHOP TROLLEY WINGMAN

129 pieces

- > As basic equipment for the workshop, basic range for beginners of all professional groups or the experienced
- > Metric dimension tools
- > Clearly arranged in GEDORE red foam modules
- > With check tool system: Completeness check using 2-colored foam inserts



Code	No.	RAL	Length mm	Width mm	Height mm
<b>3301694</b>	R22071004	3020/7016	470	724	1.034
Drawers	Max. load-bearing capacity kg	Number of drawers	Pieces	Weight kg	
5x H = 83 mm 2x H = 155 mm	450	7	129	93,64	

#### Contents

1/4" 2C-Lever reversible ratchet, fine-toothed, 72 teeth | 150 mm, 1/4" Driving handle 165 mm  
 1/4" Socket hex 4 4,5 5 5,5 6 7 8 9 10 11 12 13 14 mm  
 1/4" Socket hex 4 4,5 5 5,5 6 7 8 9 10 11 12 13 mm | 50 mm  
 1/4" Screwdriver bit socket In-hex 3 4 5 6 8 10 | 37 mm  
 1/4" Screwdriver bit socket slot 5,5 6,5 | 37 mm  
 1/4" Screwdriver bit socket cross recess PH 1 2 3 | 37 mm  
 1/4" Screwdriver bit socket cross recess PZ 1 2 | 37 mm  
 1/4" Screwdriver bit socket TX with hole T10 T15 T20 T25 T27 T30 T40 | 37 mm  
 1/4" Socket extension 100 mm, 1/4" Sliding T Bar | 115 mm,  
 1/4" Universal joint | 32 mm  
 1/2" 2C-Lever reversible ratchet, fine-toothed, 72 teeth | 250 mm  
 1/2" Socket hex 10 11 12 13 14 15 16 17 18 19 21 22 23 24 26 27 28 30 32 mm  
 1/2" Screwdriver bit socket In-hex 6 7 8 9 10 12 14 | 55 mm  
 1/2" Spark plug insert 16 21 mm | 65 mm, 1/2" Socket extension 125 250 mm  
 1/2" Sliding T Bar | 250 mm, 1/2" Universal joint | 66 mm  
 Adjustable wrench 8" 200 mm  
 Combination ratchet spanner 8 9 10 11 12 13 14 15 16 17 18 19 20 22 mm  
 Double open ended spanner 6x7 8x9 10x11 12x13 14x15 16x17 18x19 20x22 mm  
 Combination pliers 180 mm  
 Side cutter 160 mm, Flat nose pliers, straight 200 mm,  
 Screwdriver Slot 3 4 5 5,5 6 5 mm  
 Screwdriver cross recess PH 1 2, Screwdriver TX T10 T15 T20 T25 T30 T40  
 Water pump pliers 10" 250 mm, Engineer's hammer 300 g, Flat cold chisel 125 mm, 150 mm  
 Cross-cut chisels 125 mm, Centre punch 4 mm | 120 mm  
 Pin punch 4 mm | 120 mm, Drift punch 3 mm | 150 mm





## R9212 XXXX

### ENGINEERS' HAMMER

with fibreglass

- > Forged hammer head
- > Striking surfaces inductively case-hardened for tough long-term work
- > Acc. to DIN 1041
- > DIN, manufacturer and weight marked for permanence
- > Nearly unbreakable fibreglass handle



Code	No.	Head weight g	Length mm	Weight kg
3300722	R92120020	500	315	0,73
3300723	R92120032	800	350	1,1

## R9000 0006

### CHISEL & PUNCH SET

6 pieces

- > Tempered striking ends
- > Made from chrome-vanadium steel



Code	No.	Length mm	Width mm	Height mm	Pieces	Weight kg
3300826	R90000006	170	110	30	6	0,76

#### Contents

Flat cold chisel - length 125 150 mm, Cross-cut chisel - length 125 mm  
Drift punch - Ø 3 mm, Centre punch - Ø 4 mm, Pin punch - Ø 4 mm

## R9020 0106

### PIN PUNCH SET

6 pieces

- > Acc. to DIN 6450
- > Tempered striking ends
- > Made of chrome-vanadium steel



Code	No.	Length mm	Width mm	Height mm	Pieces	Weight kg
3300824	R90200106	170	110	30	6	0,82

#### Contents

Pin punch Ø 3 4 5 6 8 10 mm

## R3800 3043

### TOOL SET „MEASURING-CUTTING-SCREWS“

43 pieces

> Ideal as basic equipment for tradespeople and DIYers

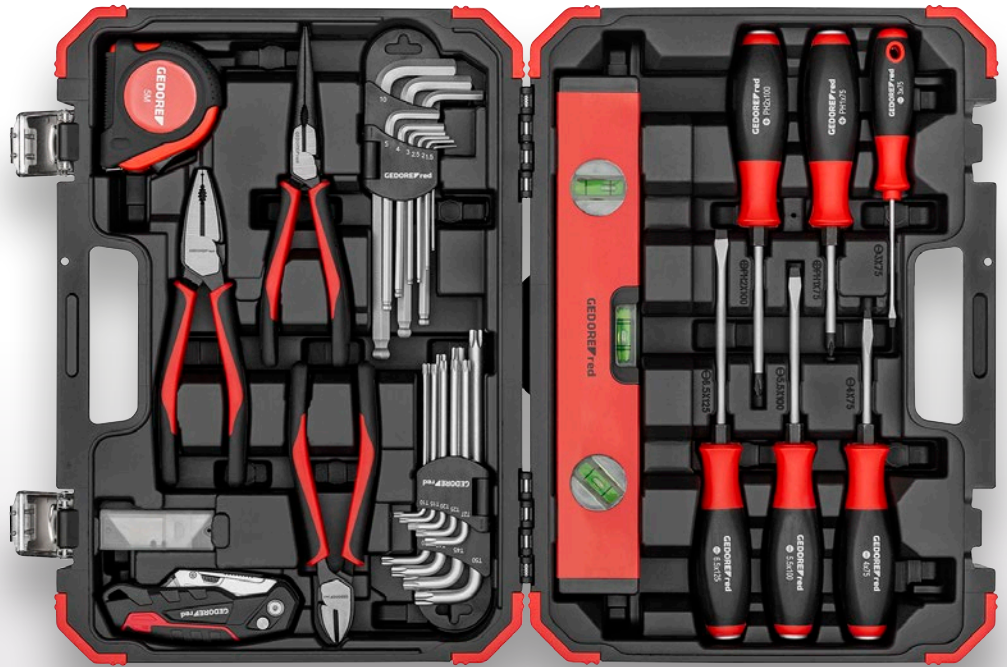

Code	No.	Contents	Length mm	Width mm	Height mm	Pieces	Weight kg
3300190	R38003043	Screwdriver slot 3 x 75 mm Screwdriver slot with striking cap 4x75 mm, 5.5x100 mm, 6.5x125 mm Screwdriver cross-recess PH with striking cap 1x75 mm, PH 2x100 mm Hexagon socket key 9 pcs. hexagon socket 1.5 2.2 2.5 3 4 5 6 8 10 long Offset screwdriver set 9 pcs TX T10 T15 T20 T25 T27 T30 T40 T45 T50, Roll tape measure, 5m Side cutters, Flat nose pliers straight, Combination pliers, Spirit level Cutter knife incl. 3 blades, 10 spare blades for cutter knife	383	272	80	43	6,2



## R3900 2005

### VDE TOOL ASSORTMENT

5 pieces

- > VDE-insulated acc. to DIN EN 60900
- > Guaranteed protection when working under voltage up to 1,000 V AC (alternating voltage) and 1,500 V DC (direct voltage)
- > 2-component-handle for a hands-friendly transfer of force



Code	No.	Pieces	Weight kg
3301414	R39002005	5	0,833

#### Contents

VDE Screwdriver slotted 3, 5.5 mm, VDE Screwdriver PH 2  
VDE Side cutter 180 mm, VDE Telephone pliers 200 mm, straight pattern

R9530 0139

# PEN LAMP

- > Ideal as a work lamp for mobile use
- > Protected against the ingress of small dust particles and splashing water
- > Good grip even with oily and sweaty hands
- > Can also be used with gloves
- > Practical clip for attaching to a belt, shirt pocket or trouser pocket



Good grip

Mobile companion

Great for outdoors



Code	No.	Luminous flux	Length mm	Width mm	Height mm	Weight kg
3301758	R95300139	130	139	15	15	0,056

R9520 0111

# MINI WORK LAMP UV

- > 2-in-1: for applications with white and UV light
- > UV light, ideal for automotive use
- > Compact dimensions save space and weight
- > Two magnets ensure variable mounting options
- > Practical clip for attaching to a belt, shirt or trousers
- > Charging time: 3 h; lighting time: up to 7 h

**2 in 1:**  
**White and UV light**

**Fixing with**  
**magnet or clip**

**Compact size with 7**  
**hours light output**



3.7 V | 2000 mAh | 7.40 Wh



Code	No.	Luminous flux	Length mm	Width mm	Height mm	Weight kg
3301763	R95200111	340	111,4	32,7	27,6	0,104

R9560 0320

# INSPECTION LAMP

- > Ideal as a work lamp for mobile use in various areas
- > 5 switching functions for adjustable brightness
- > Magnet and 180° rotatable hook provide different holding options
- > Enables flexible and mobile use, as well as hands-free work



Optimum lighting

Always positioned right

Universal use

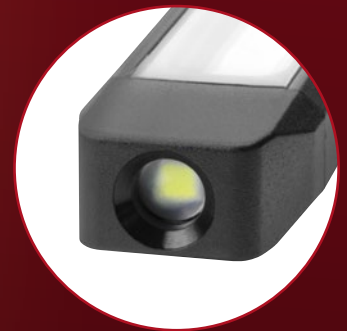

Code	No.	Luminous flux	Length mm	Width mm	Height mm	Weight kg
3301760	R95600320	500	320	33	43	0,26

R9540 0145

# SPOTLIGHT

- > Compact, portable spotlight
- > Ideal for working in places without power supply
- > Shockproof and splash-proof rubberized border
- > 180° rotatable stand

Tough  
as nails



Handy

Flexible positioning

Mobile use



Code	No.	Luminous flux	Length mm	Width mm	Height mm	Weight kg
3301761	R95400145	1.400	145	40	145	0,453



R9550 0058

# HEADLAMP 260

- > 4 light levels (50-260 lm)
- > Sturdy ABS housing
- > Charging time: 4 h; lighting time: up to 9 h
- > Gesture control for contactless switching on & off
- > Elastic headband, individually adjustable, easy take-off

## 4 light levels

## Elastic headband



## Short charging time, long lighting time

## Contactless switching on and off



					<b>3.7 V   1200 mAh   4.44 Wh</b>			



Code	No.	Luminous flux	Luminous duration h	Length mm	Width mm	Height mm	Weight kg
3301762	R95500058	260	up to 9	58	37	44	0,052

## R9325 0008

### POCKET KNIFE

#### 2C handle

- > With sawing function for fibrous materials e.g ropes and textiles
- > 2-component-handle, PP and TPR
- > Feels good in the hand thanks to the anti-slip handle shape/structure



Code	No.	Blade length mm	Total length mm	Weight kg
3301615	R93250008	87	210	0,154

## R9330 0031

### UNIVERSAL SCISSORS

- > Suitable for cutting seals and other materials (paper, cardboard, foil, leather etc.)
- > Additional small blade for thin wires and cables
- > With wire stripper for 1.0, 1.5 and 2.0 mm cables



Code	No.	Total length mm	Weight kg
3301607	R93300031	205	0,19

## R2714 0015

### ELBOW PIPE WRENCH

#### S-jaw

- > Acc. to DIN 5234
- > Mouth position 45° angled
- > Teeth offset against direction of rotation
- > Jaws polished



Code	No.	Size	Pipe-Ø	Length mm	Weight kg
3301168	R27140015	1.1/2	55	420	1,46

## R2720 2003

### CURVED JAW LOCKING PLIERS SET

#### 3 pieces

- > For clamping and gripping profiled, round and flat-section material
- > Lengthways-serrated grip surfaces
- > With adjusting screw and release lever
- > One-handed operation



Code	No.	Contents	Pieces	Weight kg
3301180	R27202003	7" 10" 12"	3	1,95

**R6800 3010**  
**EXTRACTOR SET 1/2"**  
 10 pieces

- > For slackening and removing bolts and damaged screws
- > Anticlockwise cutting thread with 6 cutting edges tapering together
- > Square drive as per DIN 3120 - C 12,5, ISO 1174, with ball retention groove



12.5mm  
 1/2"

Code	No.	Length mm	Width mm	Height mm	Pieces	Weight kg
<b>3300034</b>	R68003010	130	130	55	10	0,95

**Contents**  
 Extractor 1/2" 10 11 12 13 14 15 16 17 19 mm | 34 mm Chuck | 80 mm

**R9300 0006**  
**KEY FILE SET**  
 6 pieces

- > With wooden handle
- > Made of special steel



Code	No.	Contents	Pieces	Weight kg
<b>3301596</b>	R93000006	Triangular file Flat file Round file, Half-round file Square file	6	0,85

**R9350 0170**  
**TWIST DRILL BIT SET, ROLLED**  
 170 pieces

- > HSS twist drills DIN 338, type N, right-hand cutting
- > Tip angle: 118°



Code	No.	Contents	Length mm	Width mm	Height mm	Pieces	Weight kg
<b>3301612</b>	R93500170	each 10x Twist drill bit, rolled 1.0 1.5 2.0 2.5 3.0 3.5 4.0 4.5 5.0 5.5 6.0 6.5 7.0 7.5 8.0 mm each 5x Twist drill bit, rolled 8.5 9.0 9.5 10.0 mm	335	240	54	170	3,724

# GEDORE

TOOLS FOR LIFE

## **GEDORE Werkzeugfabrik GmbH & Co. KG**

Remscheider Straße 149  
42899 Remscheid · GERMANY  
Tel. + 49 (0) 21 91-596 - 0  
Fax + 49 (0) 21 91-596 - 230  
info@gedore.com  
www.gedore.com

Vertrieb Deutschland  
Tel. + 49 (0) 21 91-596 - 900  
Fax + 49 (0) 21 91-596 - 999

## **GEDORE Automotive GmbH**

Breslauer Straße 41  
78166 Donaueschingen · GERMANY  
Tel. +49 771 83223-0  
Fax +49 771 83223-90  
info.gam@gedore.com  
www.gedore-automotive.com

## **GEDORE Torque Solutions GmbH**

Bertha-Benz-Straße 12  
71665 Vaihingen/Enz · GERMANY  
T +49 7042 9441-0  
F +49 7042 9441-41  
torque-solutions@gedore.com

## **GEDORE AUSTRIA GmbH**

Gedore-Str. 1  
8190 Birkfeld / Stmk. · AUSTRIA  
Tel. +43 (0) 3174 / 363 64 00  
Fax +43 (0) 3174 / 363 83 20  
sales.austria@gedore.com  
www.gedore.at

## **GEDORE Tools S.A. (Pty) Ltd.**

103 Qashana Khuzwayo (Shepstone) Road,  
New Germany, 3610 - South Africa  
PO Box 68, New Germany, 3620  
SOUTH AFRICA  
Tel. +27 (0) 31 / 705 3587  
Fax +27 (0) 31 / 705 32770  
esales@gedore.co.za  
www.gedore.co.za

## **GEDORE IBÉRICA S.L.**

c/Arangutxi 12, Poligono Industrial de Júndiz  
01015 Vitoria Alava · SPAIN  
Tel. +34-945-29 22 62  
Fax +34-945-29 21 99  
gedore@gedore.es  
www.gedore.es

## **GEDORE Torque Ltd**

(Formerly Gedore UK)  
Tannery Lane, Gosden Common  
Bramley, Guildford  
Surrey  
GU5 0AJ · UNITED KINGDOM  
Tel. +44 (0) 1756 / 70 67 00  
sales@gedoreuk.com  
www.gedoreuk.com

## **GEDORE France SARL**

Parc d'activités des Béthunes - La Mare II  
10, avenue du Fief - Bât. 12  
BP 79144 Saint-Ouen-l'Aumône  
F-95074 Cergy Pontoise Cedex · FRANCE  
Tél. +33 (0)1 34 40 16 60  
Fax +33 (0)1 34 40 16 61  
jadore@gedore.fr  
www.gedore.fr

## **GEDORE TECHNAG B.V.**

Flemingweg 7, 2408 AV  
Alphen aan den Rijn · NETHERLANDS  
Tel. +31 (0) 172 / 42 73 50  
Fax +31 (0) 172 / 42 73 60  
info@gedore.nl  
www.gedore.nl

## **GEDORE (INDIA) Private Limited**

148, Sector 3, IMT Manesar  
Gurgaon - 122051  
Haryana · INDIA  
Tel. +91 (0) 124 22910 - 65/66/67  
Fax +91 124 2341067  
sales@gedoreindia.com  
www.gedore.in

## **GEDORE POLSKA Sp. z o.o.**

ul. Żwirki i Wigury 56a  
43-190 Mikołów · POLAND  
Tel. +48 (0) 32 / 738-40 10  
Fax +48 (0) 32 / 738-40 20  
gedore@gedore.pl  
www.gedore.pl

## **Ferramentas GEDORE do Brasil S.A.**

Rua Vicentina Maria Fidélis,  
275 Bairro Vicentina  
São Leopoldo - RS | 93025-340 · BRAZIL  
Tel. +55 51- 3589 9200  
Fax + 55 51- 3589 9222  
export@gedore.com.br  
www.gedore.com.br

## **GEDORE TOOLS**

300 Langner Rd  
Suite 250  
West Seneca, NY 14224 · USA  
Phone: +1 (843) 225 5015  
Fax: +1 (843) 300 0315  
info@gedoretools.com  
www.gedoretools.com

## **GEDORE Tool Trading (Shanghai) Co., Ltd.**

1/F, Block 2, 1358 Pingan Road,  
Minhang, Shanghai · CHINA 201109  
Tel. +86-21-3388 7258  
Fax +86-21-3388 7259  
Service Hotline: 400 880 1858  
info@gedore.cn  
www.gedore.cn

Your dealer / stamp:

**Brands of the GEDORE Group**  
gedore.com · ochsenkopf.com

**IMPULSE TOOL PROMOTION** valid  
from 01/03/2025 until 31/12/2025.  
While stocks last.

\*Delivery without decoration. Technical specifications subject to modifications.  
No liability for printing errors. Please ask your local dealer.

**gedore.com**